

Eagle 21 R-9s

JP Racing

Eagle



Option	
9mm	F24490
8mm	F24480
7,5mm	F24475
7mm	F24470
6,5mm	F24465

0.10	F03001
0.15	F03002
0.20	F03003
0.25	F03004
0.30	F03005
SET(5)	F03006

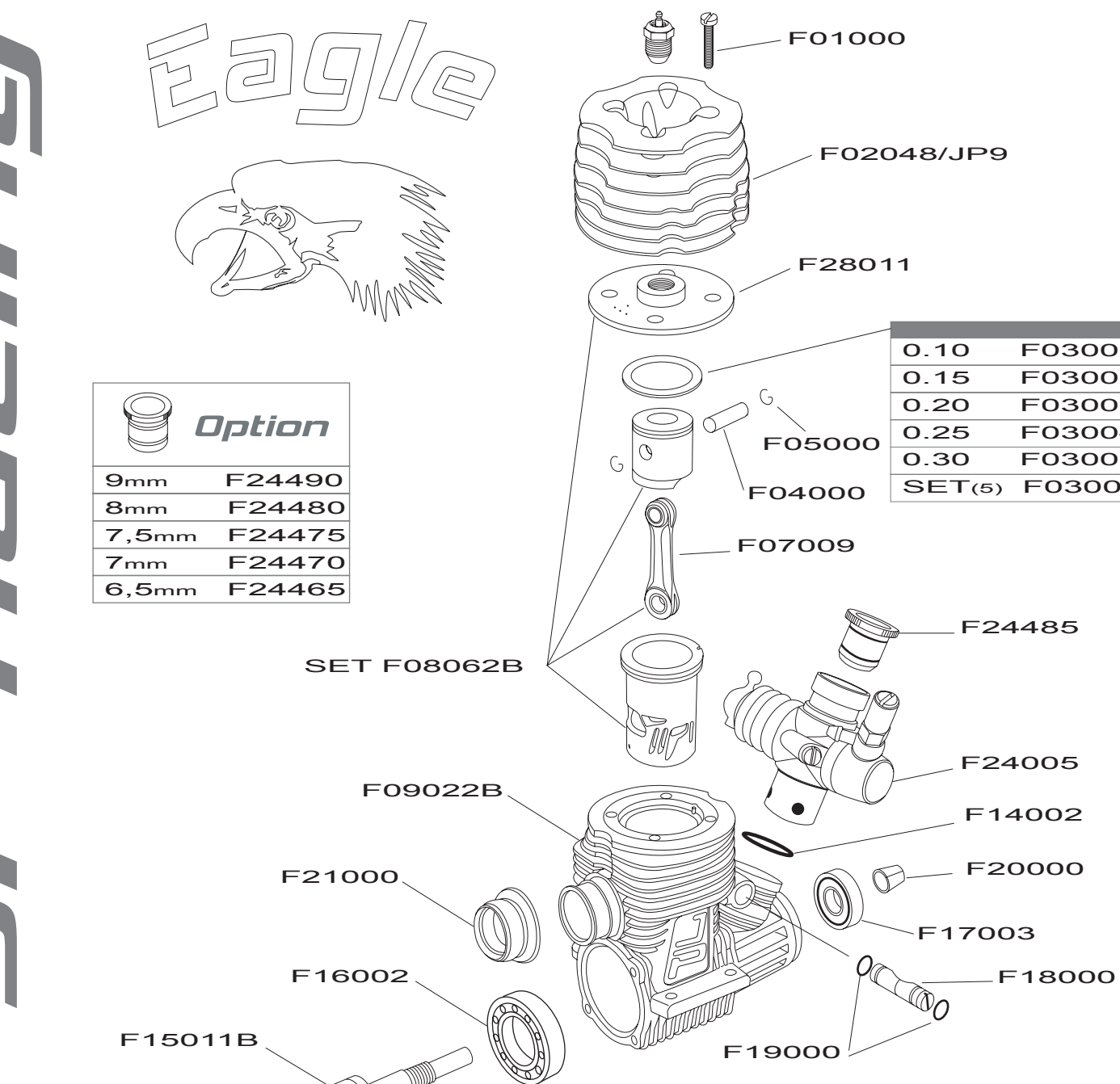

Carburetor

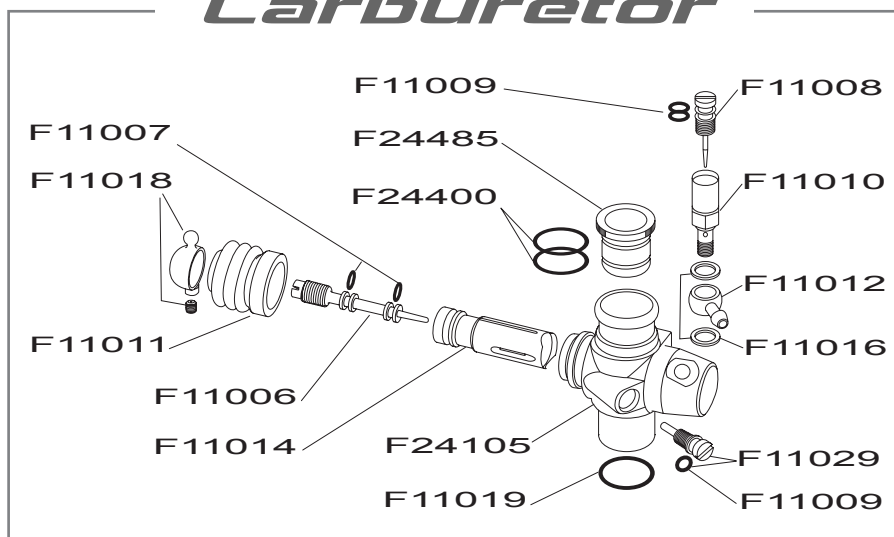

READ CAREFULLY THESE INSTRUCTIONS BEFORE USING YOUR ENGINE!

Thank you for choosing this engine. The FX 21 arises from important technological researches, what guarantees the best quality in the material choice and the manufacture of this engine. The FX 21 arises from competitions and JP RACING's long experience in this domain.

FUEL

The FX 21 engine has been conceived to only use car fuel. There are a lot of fuels on the market, as plane fuel, but use exclusively the one intended for cars. We also recommend you to use some up-market fuel. Some middle- and bottom-of-the-range fuels contain nitromethane strong in acid which could oxidize some engine parts in the long term. The bad quality methanol can contain an important concentration of water what can also lead to the corrosion of engine parts. It is important that the used fuel contains enough oil to avoid the superheating of the engine. In the worst case, the engine parts can be damaged by a lack of lubricant even before the engine is in superheating. To avoid any fuel problem, we advise you the JP RACING FUEL we use in competitions.

AIR FILTER

Please ask your retailer for a foam air filter. Make sure to well-soak the foam of the filter with JP RACING oil #90109. The filter will be ineffective without the special oil for foam filters. An excessive wear and the breakage of engine parts can be the result of the use of a badly maintained air filter. Make sure that the air filter is always clean and well-oiled at every engine use.

GLOW-PLUGS

Use JP RACING glow plugs for your engine. A bad quality glow plug makes the engine adjustment more difficult. Check the state of your glow plug before use to prevent the engine starting problems. If the glow plug is damaged after use of the engine, check carefully the engine before its new run, especially if the wire fell in the engine.

BREAK-IN

Take time for the engine break-in. Do not skip this important stage for its longevity. The time you will spend for your FX 21 break-in will insure its longevity and better performances.

Avoid too fast driving during the break-in period. An excessive speed is the first cause of a bad break-in. Be sure of the good quality of your fuel. We recommend high-quality fuel for your engine. A low-quality fuel makes the engine overheat and leads to a premature wear of its parts.

During the break-in period, it is very important to have a good air filter and not to let the dust enter into the engine.

During the break-in period the engine has to have a richly settled carburetion (main needle). This regulation is compulsory for a perfect lubrication of the engine parts, which are new and well adjusted for a maximal later performance. After a short period of slow motion functioning with a stable and not too high R.P.M, you can push the gas and run straight lines or track laps to begin the engine break-in. It is important to make sure that when the gas handle is full speed, the engine cannot take all its R.P.M but only approximately the half. To obtain this adjustment, it is necessary to open the main needle of about 1 turn counterclockwise with regard to the initial adjustment without touching the other screws. It can be necessary to raise the idling speed if it is too weak after this adjustment.

The voluntarily too rich settled engine will be well lubricated and will have a perfect break-in start. This adjustment will be used during approximately 3 fuel tanks and it will gradually be necessary to close the main needle tank after tank until be close to the right adjustment, while still being a little bit rich (this operation must take approximately 7 full fuel tanks). At every tank fill you are now able to finish the regulation of your engine and its break-in. You must keep a slightly rich adjustment during all this period. During the use, you will feel that it is the end of the break-in because the engine releases itself and rises in performance without a touch at its adjustments. After the break-in, it will be compulsory to check your engine or to give it to your retailer to make this operation. The connecting rod being the part the most in operation during the break-in, it will be necessary to replace it to avoid any breakage problem.

ENGINE ADJUSTMENT

Further to the break-in, and after checking the engine, it will be necessary to find the optimal regulation and to make sure of its perfect stability in running. A stable idling speed on a warm engine, is always very good sign. An idling speed on 2 times is the sign of an overheating engine, then too lean settled. The last engine adjustments are realised by 1/8 turns. Take your time for this last adjustment...

Be careful not to settle your engine too lean and especially not to prolong its use adjusted so. A too lean adjustment is often very critical for the engine and entails irreversible damages. Watch to always have a limit rich adjustment and not the opposite.

It is also important to well-settle the base speed of the engine to have good response and constant accelerations. An engine which badly restarts at low RPM after a long straight line is settled too lean. An engine which restarts badly and cuts at low RPM in the slow corners of the track is too lean in the bottom. It is especially necessary to take care of having a good clutch system to obtain a perfect adjustment. A bad clutch system leans to a difficult engine adjustment and quickly damages the piston-sleeve set.

MAINTENANCE

When you stopped running for the day with your engine, make sure you have used all the fuel contained in it. This will prevent any corrosion of the internal engine parts. Remove the air filter, the rear cover and the glow plug of the engine. Put some after-run oil on the internal parts of the engine but without excess (JP after-run oil # 91000). We do not recommend spray oils which risk to damage the red past put inside the crankshaft. Do not soak the crankshaft in a solvent. Clean and dry it immediately during the maintenance to avoid damaging the red past. Disassemble your engine only after having cleaned it outside. Use only good quality tools not to damage the engine screws. Control the perfect geometry of the crankpin before replacing the connecting rod.

If these operations seem too difficult to you, you can always ask your hobby shop or retailer who can take care of it or will appeal to our JP RACING local agent.

Have fun with JP RACING engines !

